









C5e UTP PATCH CORD

產品編號 : 50032

產品品名 : 3A-CBL-E2U3MRD63Z

台製 3ANET C5e 跳線 UTP 3米 PVC 紅色

T568B WIRE MAP							
OR/WH	1		1	OR/WH			
OR	2		2	OR			
GN/WH	3		3	GN/WH			
GN	6		6	GN			
BL/WH	5		5	BL/WH			
BL	4		4	BL			
BR/WH	7		7	BR/WH			
BR	8		8	BR			

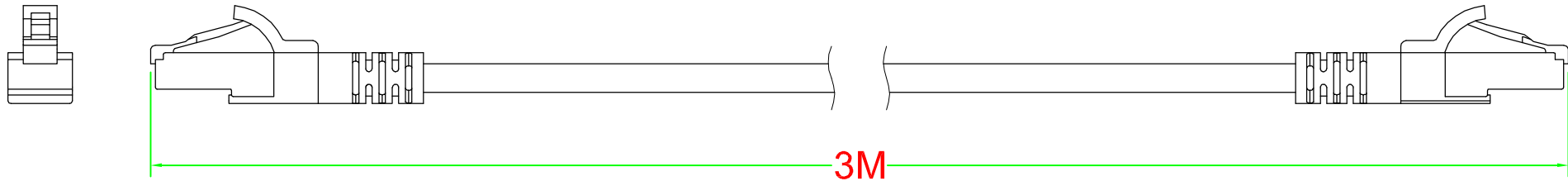

Performance:

Meets C5e EIA/TIA 568C Standard.

Materials :

Cable : 24 AWG Bare Copper

Jacket : PVC

PLUG : PC / UL-94V2

Contact : Phosphor Bronze / 50 micro inches gold plated

Boot : PVC

Electrical Specifications:

Insulation Resistance : 500M ohms (min.)

Contact Resistance : 20m ohms (max.)

DC Resistance : 0.1 ohms (max.)

Current Rating : 1.5 Amps .

Withstanding Voltage : 1000 VAC RMS @ 60Hz / 1 min.

Mechanical Specifications:

Tensile Strength : 7.7 Kgs

Operation Temperature : -20 °C ~ +70 °C